

MV-SC3050XC

5 MP Color Vision Sensor



Introduction

With built-in high-precision vision algorithms, MV-SC3050XC vision sensor can realize counting, existence, measurement, recognition and other functions. It can be easily configured and operated via the SCMVS client software, and it uses RS-232 and Ethernet to output vision tool results and customized results.

Applicable Industry

Consumer electronics, food and pharmaceutical, automobile, etc.

Available Model

- 8 mm focal length: MV-SC3050XC-08M-WBN
- 12 mm focal length: MV-SC3050XC-12M-WBN
- 16 mm focal length: MV-SC3050XC-16M-WBN

Key Feature

- Adopts embedded hardware platform to realize high-speed image processing.

- Built-in high-precision positioning, measurement and recognition algorithms for counting, defects, existence, positioning and other functions.
- Supports RS-232, TCP, UDP, FTP, ModBus, PROFINET, EtherNet/IP and other communication modes.
- Adopts multiple IO interfaces for input and output signals.
- Supports viewing the device's status in real time via 360° visual indicator, convenient for debugging and maintenance.
- Rotatable cable tail design, suitable for narrow space.
- Adopts polarized, diffused, and full-transparent multiple optical lighting with good environmental adaptability.
- IP67 protection without fear of harsh industrial application environments.

Specification

Model	MV-SC3050XC-08M-WBN	MV-SC3050XC-12M-WBN	MV-SC3050XC-16M-WBN
Tool			
Vision tool	<ul style="list-style-type: none"> ● Count: Spot count, edge count, pattern count, contour count, color count ● Defect detection: Exception detection ● Existence: Circle existence, line existence, spot existence, edge existence, pattern existence, contour existence ● Location: Match calibration, match location, position fixture ● Logic tool: If module, condition judge, logic judge, combination judge, string comparison, calculator ● Measurement: Color size, L2L angle, diameter measurement, brightness analysis, contrast measurement, width measurement, P2L measurement, greyscale size, line angle, edge width measurement ● Recognition: OCR, code recognition, color contrast, color recognition, classification registration, object detection registration ● Deep learning: DL object detection, DL classification 		
Solution capacity	Supports importing and exporting project, up to 32 projects can be stored.		
Communication protocol	RS-232, TCP, UDP, FTP, PROFINET, ModBus, EtherNet/IP, MELSEC/SLMP, FINS, Keyence KV		
Camera			
Sensor type	CMOS, global shutter		
Pixel size	3.45 μm × 3.45 μm		
Sensor size	1/1.45"		
Resolution	2432 × 2048		
Max. frame rate	40 fps		
Dynamic range	77.8 dB		
SNR	43 dB		
Gain	0 dB to 15 dB		
Exposure time	6 μs to 1 sec		
Pixel format	RGB 8, Mono 8		
Mono/color	Color		
Electrical feature			
Data interface	Fast Ethernet (100 Mbit/s)		
Digital I/O	12-pin M12 connector provides power and I/O, including opto-isolated input (LINE 0/1/2) × 3, opto-isolated output (LINE 3/4/5) × 3, and RS-232 × 1 Supports triggering device via pressing top trigger button		
Power supply	24 VDC		
Power consumption	Approx. 6.5 W@24 VDC		
Mechanical			
Lens mount	M12-mount, mechanical autofocus supported		
Focal length	8 mm (0.3")	12 mm (0.5")	16 mm (0.6")
Lens cap	Polarized + diffused + full-transparent lens cap		
Light source	White spot light source. Red/blue/IR point light source is optional		
Aiming system	Orange LED		
Indicator	360° visual indicator		
Dimension	Straight angle: 80.1 mm × 43 mm × 44.3 mm (3.2" × 1.7" × 1.7") Right angle: 58.5 mm × 43 mm × 65.4 mm (2.3" × 1.7" × 2.6")		
Weight	Approx. 190 g (0.4 lb.)		

Specification

Model	MV-SC3050XC-08M-WBN	MV-SC3050XC-12M-WBN	MV-SC3050XC-16M-WBN
Ingress protection	IP67 (under proper installation of waterproof lens cap)		
Temperature	Working temperature: 0 °C to 50 °C (32 °F to 122 °F) Storage temperature: -30 °C to 70 °C (-22 °F to 158 °F)		
Humidity	20% to 95% RH, non-condensing		
General			
Client software	SCMVS		
Certification	CE, KC		

Detection Range

Lens focal length	Installation distance	Field of View	Single Pixel Accuracy
8 mm	25 mm	26.22 mm × 22.08 mm	0.011 mm
	2000 mm	2097.6 mm × 1766.4 mm	0.863 mm
12 mm	60 mm	41.95 mm × 35.33 mm	0.017 mm
	2000 mm	1398.4 mm × 1177.6 mm	0.575 mm
16 mm	100 mm	52.44 mm × 44.16 mm	0.022 mm
	2000 mm	1048.8 mm × 883.2 mm	0.431 mm

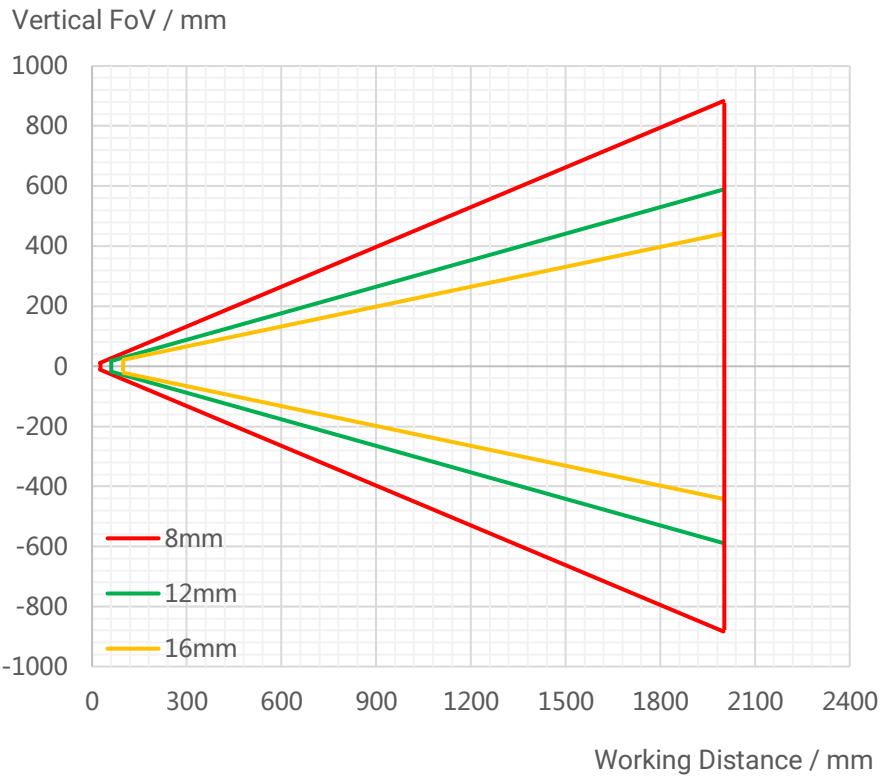

Dimension

Device (Straight Angle):

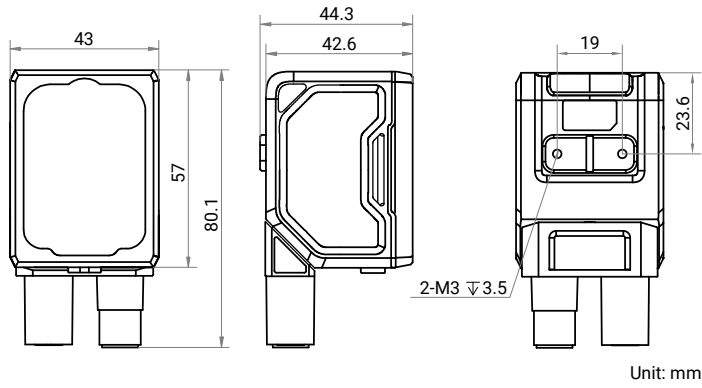

Device (Right Angle):

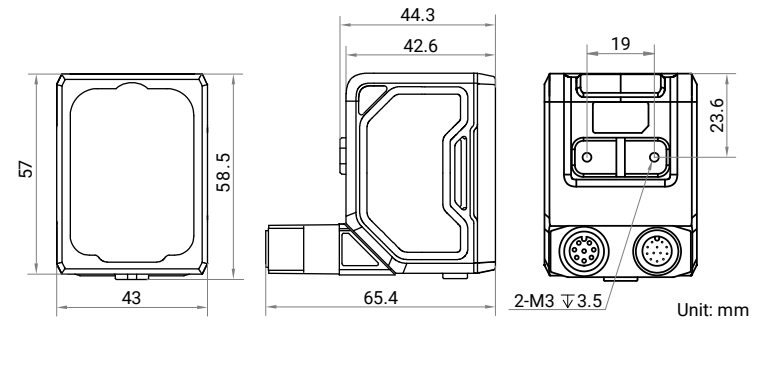

Device and Installation Bracket (Straight Angle):

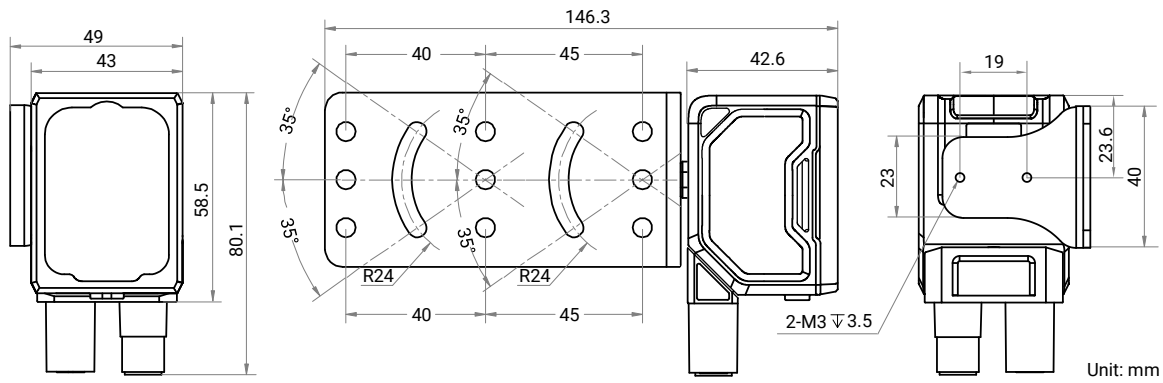

Device and Installation Bracket (Right Angle):

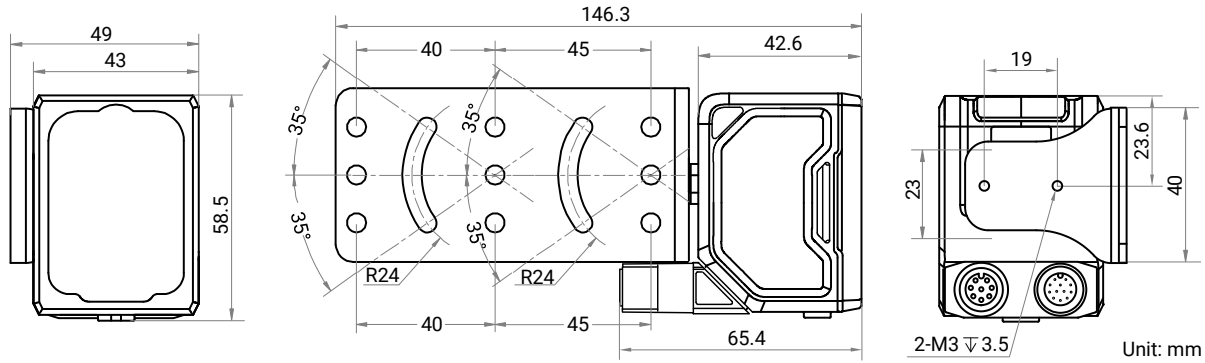

Installation Bracket:

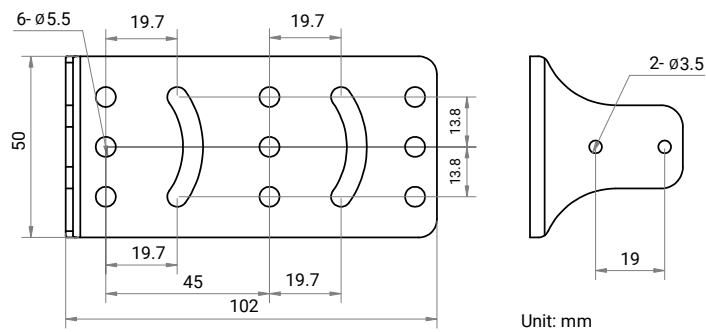

Hangzhou Hikrobot Co. Ltd.
en.hikrobotics.com